

Installation and Operation Manual

KBMM™

Surface Mount Technology

Solid State SCR

DC Motor Speed Controls

for Use with 1/100 – 3 HP, 90 and 180 Volt
Permanent Magnet and Shunt Wound DC Motors*

AC Line Input: 115 and 208/230 Volts, 50/60 Hz

This Manual Covers Models KBMM-125, 225, 225D

Ultra Fast Current Limit Circuit Prevents
Demagnetization in Permanent Magnet Motors



See Safety Warning on page 6.

The information contained in this manual is intended to be accurate. However, the manufacturer retains the right to make changes in design which may not be included herein.

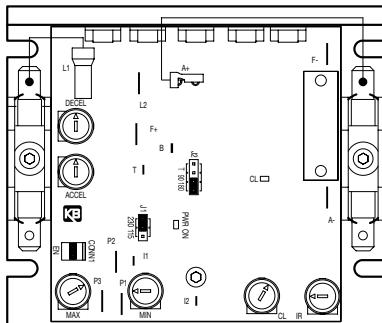

PATENTED



*See page 6
for CE
Information

A Plug-In Horsepower Resistor® and AC Line and Armature Fuses, supplied separately, must be installed for this product to operate.

*Auxiliary Heat Sink (Part No. 9861) is required to achieve maximum rating of control. See Electrical Ratings, Table 1, on page 9.

PENTA POWER™

A COMPLETE LINE OF MOTOR DRIVES

Manufactured
in the USA

© 2004 KB Electronics, Inc.
(See back cover)

TABLE OF CONTENTS

Section	Page
1 Simplified Installation Instructions	4
2 Safety Warning	6
3 Introduction	7
4 Application Information	11
5 Mounting Instructions	12
6 Wiring Instructions	13
7 Setting Selectable Jumpers	19
8 AC Line and Armature Fusing	20
9 Plug-In Horsepower Resistor®	21
10 Recommended High Voltage Dielectric Withstand Testing (Hi-Pot Testing)	22
11 Trimpot Adjustments	24
12 Diagnostic LEDs	28
13 Switching Circuits	28
14 Optional Accessories	30
Limited Warranty	32

Tables

1 Electrical Ratings	9
2 General Performance Specifications	9
3 Minimum Supply Wire Size Requirements	13
4 Field Connection (Shunt Wound Motors Only)	14
5 AC Line and Armature Fuse Selection	21
6 Plug-In Horsepower Resistor® Selection	22
7 RFI Filter Selection	31

TABLE OF CONTENTS (Continued)

Figures	Page
1 Control Layout and General Connection Diagram	10
2 Mechanical Specifications	11
3 Remote Main Speed Potentiometer Connection	15
4 Voltage Following Connection	15
5 Enable Switch or Contact Wired to the Enable Connector	16
6 Enable Switch or Contact Wired to the Main Speed Potentiometer	17
7 Inhibit Switch or Contact Wired to the Inhibit Terminals	17
8 DC Tach-Generator Connection (7 Volts per 1000 RPM)	18
9 DC Tach-Generator Connection (50 Volts per 1000 RPM)	18
10 Other DC Tach-Generator Connection (with Addition of RT)	19
11 AC Line Input Voltage Selection (Jumper J1 (Model KBMM-225D Only))	20
12 Motor Voltage and DC Tach-Generator Selection (Jumper J2)	20
13 Hi-Pot Test Setup	23
14 Acceleration Trimpot (ACCEL) Range	24
15 Deceleration Trimpot (DECEL) Range	25
16 Minimum Speed Trimpot (MIN) Range	25
17 Maximum Speed Trimpot (MAX) Range	25
18 Current Limit Trimpot (CL) Range	26
19 IR Compensation Trimpot (IR) Range	27
20 Typical Dynamic Brake Circuit Connection	29

Items Included in this package – KBMM™ Speed Control, KBMM™ Installation and Operation Manual, Hardware Bag (contains Main Speed Potentiometer with insulator and mounting hardware, (9) – 0.25" female crimp-on terminals, (4) – 0.11" female crimp-on terminals, and an Enable harness), CE Approved Product Information Card, and Warranty Registration Card.

Items required to operate this control – Plug-In Horsepower Resistor®, AC Line Fuse and Armature Fuse. Supplied through your distributor. See Sections 8 and 9, on pages 20-22.

1 SIMPLIFIED INSTALLATION INSTRUCTIONS

IMPORTANT – Read these simplified installation instructions before proceeding. These instructions are to be used as a reference only and are not intended to replace the detailed instructions provided herein. You must read the Safety Warning, on page 6, before proceeding.

Note: A Plug-In Horsepower Resistor® and AC Line and Armature Fuses, supplied separately, must be installed in order for this product to operate. See Section 9, on page 21.

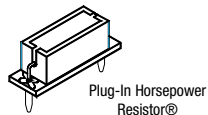

- 1.1 AC Line Connection** – Wire the AC line to Terminals “L1” (Line Fuse) and “L2”, as shown in Figure 1, on page 10 and as described in Section 6.1, on page 13.

Model KBMM-125 is rated for 115 Volt AC line input only. Model KBMM-225 is rated for 230 Volt AC line input only. Model KBMM-225D is rated for 115 Volt AC line input (Jumper J1 in the “115” position) and 230 Volt AC line input (Jumper J1 in the “230” position). See Section 7.1, on page 19.

Notes: **1.** The rated AC line voltage (115, 208/230) of the control must match the actual AC line input voltage. **2.** If one of the AC line inputs is a neutral (N), wire it to Terminal “L2”.

- 1.2 Ground Connection** – Connect the ground wire (earth) to the control chassis.
- 1.3 Motor Connection** – Connect the motor to Terminals “A+” (Armature Fuse) and “A-”, as shown in Figure 1, on page 10, and as described in Section 6.3, on page 14.
- 1.4 Jumper Settings** – Jumper J1 (on Model KBMM-225D only) and Jumper J2 (all models) have been factory set for most applications, as shown in Figure 1, on page 10, and as described in Section 7, on page 19.

- 1.5 **AC line Fusing** – It is required that an AC line fuse (supplied separately) be installed in the AC Line Fuse Holder, as shown in Figure 1, on page 10. Select the correct AC Line Fuse, as described in Section 8, on pages 20 and 21. Fuse each conductor that is not at ground potential.
- 1.6 **Armature Fusing** – It is required that an Armature Fuse (supplied separately) be installed in the Armature Fuse Holder, as shown in Figure 1, on page 10. Select the correct Armature Fuse as described in Section 8, on pages 20 and 21.
- 1.7 **Plug-In Horsepower Resistor®** – Install the correct Plug-In Horsepower Resistor® according to armature voltage and motor horsepower, as shown in Figure 1, on page 10. Select the correct Plug-In Horsepower Resistor®, as described in Section 9, on pages 21 and 22.
- 1.8 **Trimpot Settings** – All trimpots have been factory set for most applications, as shown in Figure 1, on page 10. The trimpots may be readjusted, as described in Section 11, on page 24.
- 1.9 **Diagnostic LEDs** – After power has been applied to the control, observe the LEDs to verify proper control operation, as described in Section 12, on page 28.
- 1.10 **Auxiliary Heat Sink (Part No. 9861)** – Extends the horsepower rating of the control to 1.5 HP for controls with 90 Volt DC output and 3 HP for controls with 180 Volt DC output.

2 SAFETY WARNING – Please read carefully.

Definition of Safety Warning Symbols:



Electrical Hazard Warning Symbol – Failure to observe this warning could result in electrical shock or electrocution.



Operational Hazard Warning Symbol – Failure to observe this warning could result in serious injury or death.



This product should be installed and serviced by a qualified technician, electrician, or electrical maintenance person familiar with its operation and the hazards involved. Proper installation, which includes wiring, mounting in proper enclosure, fusing or other over current protection, and grounding can reduce the chance of electrical shocks, fires, or explosion in this product or products used with this product, such as electric motors, switches, coils, solenoids, and/or relays. Eye protection must be worn and insulated adjustment tools must be used when working with control under power. This product is constructed of materials (plastics, metals, carbon, silicon, etc.) which may be a potential hazard. Proper shielding, grounding, and filtering of this product can reduce the emission of radio frequency interference (RFI) which may adversely affect sensitive electronic equipment. It is the responsibility of the equipment manufacturer and individual installer to supply this Safety Warning to the ultimate end user of this product. (SW effective 11/1992). Be sure to follow all instructions carefully. Fire and/or electrocution can result due to improper use of this product.



This product complies with all CE directives pertinent at the time of manufacture. Contact the Sales Department for Declaration of Conformity. Installation of a CE approved RFI filter is required (see Section 14.12, on page 30). Additional shielded cable and/or AC line cables may be required along with a signal isolator (SI-6 (Part No. 9444)).

3 INTRODUCTION

Thank you for purchasing the KBMM™ “Standard of the Industry” full-wave variable speed DC motor control, *now with SMT construction*. The control offers the user the ultimate in reliability and performance at an affordable price. The controls contain a unique patented super-fast Direct-Fed™ current limit circuit that protects the SCR power bridge against direct shorts¹. The reliability of the control is further enhanced with the use of high-surge, 25 Amp SCRs, and AC line and armature fusing^{2,3}. The control is designed with KB’s exclusive Plug-In Horsepower Resistor®³, which eliminates the need for recalibrating IR Comp and Current Limit when the control is used on various horsepower motors. In addition, the rating of the control can be extended to 1.5 HP for controls with 90 Volt DC output and 3 HP for controls with 180 Volt DC output, by the use of KB’s Auxiliary Heat Sink⁴. Models KBMM-225 and KBMM-225D also allow operation of 90 Volt DC motors when used on 208/230 Volt AC line input⁵.

The versatility of the control is confirmed by its extensive list of standard features, such as: selectable armature and tach feedback and adjustment trimpots for minimum speed, maximum speed, current limit, IR compensation, and linear acceleration and deceleration. The control includes Auto-Inhibit®, which eliminates surging during rapid AC line switching; pulse transformer triggering, which provides cogless operation at low speed; and superior noise rejection circuitry, which eliminates false starts and blown SCRs. Enable (normally closed) and Inhibit (normally open) functions provide electronic switching of control output.

The output voltage of the control is a linear function of the Main Speed Potentiometer rotation. In addition, the control can be used in a voltage following mode by supplying an *isolated* analog input signal to Terminals “P2” (+) and “P1” (-)⁶. The control is compact in size (only 4.30” X 3.64” X 1.25”) and easily replaces all competitive speed controls. The control is supplied with a 5 k Ω Main Speed Potentiometer and QD terminals. All models are UL Listed (USA and Canada) and CE Approved.

Notes: **1.** Short circuit protected at motor only. **2.** KB Limited Warranty applies. See page 32. **3.** Fuses and Plug-In Horsepower Resistor® supplied separately. See Sections 8 and 9, on pages 20 - 22. **4.** Part No. 9861. See Section 14.1, on page 30. **5.** Step-Down operation. **6.** If an isolated signal input is not available, or if using a 4 - 20 mA DC signal input, install the optional plug-on SI-6 Signal Isolator (Part No. 9444).

3.1 Standard Features

- 1 **Plug-In Horsepower Resistor®** – Eliminates the need to calibrate the control for IR Compensation and Current Limit when used on various horsepower motors.
- 2 **Auto-Inhibit®** – Allows the control to be rapidly switched “on” and “off” using the AC line.
- 3 **Inhibit and Enable** – Allows the control to be turned “on” and “off” using electronic switching.
- 4 **Trim pots** – Minimum Speed (MIN), Maximum Speed (MAX), IR Compensation (IR), Current Limit (CL), Acceleration (ACCEL), and Deceleration (DECEL).
- 5 **Jumpers** – AC Line Input Voltage Selection (J1 (Model KBMM-225D only)), Motor Voltage and DC Tach-Generator Selection (J2).
- 6 **Protection Features** – MOV transient protection. Short Circuit protected (at motor only).
- 7 **Diagnostic LEDs** – Power On (PWR ON) and Current Limit (CL).
- 8 Model KBMM-125 operates on 115 Volt AC line input with 90 Volt DC motors.
- 9 Model KBMM-225 operates on 230 Volt AC line input with 180 Volt DC motors or 90 Volt DC motors (step-down). - Jumper Selectable.
- 10 Model KBMM-225D can operate on 115 Volt AC line input with 90 Volt DC motors and 230 Volt AC line input with 180 Volt DC motors or 90 Volt DC motors (step-down). - Jumper selectable.
- 11 Armature or DC Tach-Generator feedback.
- 12 Built-in AC line and armature fusing.
- 13 Main Speed Potentiometer (5 k Ω).
- 14 SMT construction.

TABLE 1 – ELECTRICAL RATINGS

Model	Part No.	AC Line Voltage (±15%, 50/60Hz) (Volts AC)	Motor Voltage (Volts DC)	Maximum Rating without Auxiliary Heat Sink			Maximum Rating with Auxiliary Heat Sink			Field Voltage (Volts DC)
				AC Line Current (RMS Amps)	DC Load Current (Avg. Amps)	Horsepower (HP (kw))	AC Line Current (RMS Amps)	DC Load Current (Avg. Amps)	Horsepower (HP (kw))	
KBMM-125	9449	115	0 - 90	12.0	8.0	.75 (.6)	24.0	16.0	1.5 (1.1)	50, 100
KBMM-225	9450	230	0 - 180	12.0	8.0	1.5 (1.1)	24.0	16.0	3 (2.3)	100, 200
			0 - 90*	12.0	8.0	.75 (.6)	24.0	16.0	1.5 (1.1)	100
KBMM-225D	9451	115	0 - 90	12.0	8.0	.75 (.6)	24.0	16.0	1.5 (1.1)	50, 100
			0 - 180	12.0	8.0	1.5 (1.1)	24.0	16.0	3 (2.3)	100, 200
		230	0 - 90*	12.0	8.0	.75 (.6)	24.0	16.0	1.5 (1.1)	100

* Step-down operation.

TABLE 2 – GENERAL PERFORMANCE SPECIFICATIONS

Description	Specification	Factory Setting
Speed Range (Ratio)	50:1	—
Armature Feedback Load Regulation (0 - Full Load, 50:1 Speed Range) (% Base Speed)	1	—
Tach-Generator Feedback Load Regulation (0 - Full Load, 50:1 Speed Range) (% Set Speed)	1	—
Line Voltage Regulation (at Full Load, ± 10% Line Variation) (% Speed)	0.5	—
Control Linearity (% Output Voltage vs Signal Input Voltage)	2	—
Acceleration (ACCEL) Trimpot Range (Seconds)	0.2 – 10	2
Deceleration (DECEL) Trimpot Range (Seconds)	0.2 – 10	2
Maximum Speed (MAX) Trimpot Range (% Base Speed)	50 – 110	100
Minimum Speed (MIN) Trimpot Range (% Base Speed)	0 – 30	0
Current Limit (CL) Trimpot Range (% Full Load)	0 – 200	150
IR Compensation (IR) Trimpot Range (at Specified Full Load @ 90, 180 Volts DC Output) (Volts DC)	0 – 24, 48	3, 6

Notes: 1. Step-down operation: motor may have reduced brush life. Consult motor manufacturer. 2. Performance is for SCR rated permanent magnet motors only. Lower performance can be expected with other motor types. Factory setting is for 3% load regulation. To obtain superior regulation, see Section 11.6, on page 27.

FIGURE 1 – CONTROL LAYOUT & GENERAL CONNECTION DIAGRAM (Model KBMM-225D Shown)

(Note: Control is set for 208 /230 VAC line input, 0-180 VDC output with armature feedback)

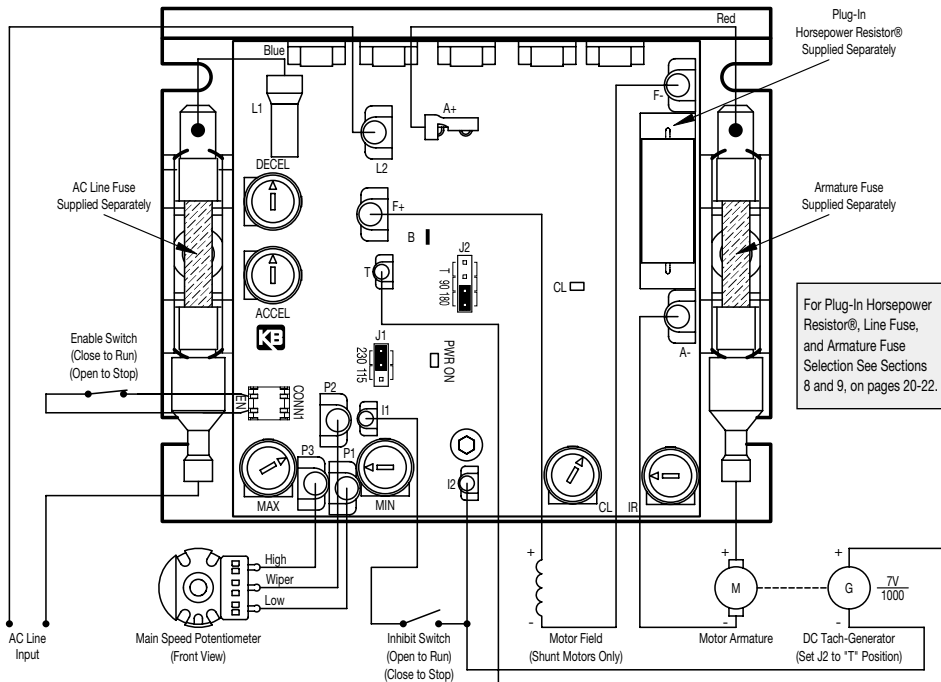
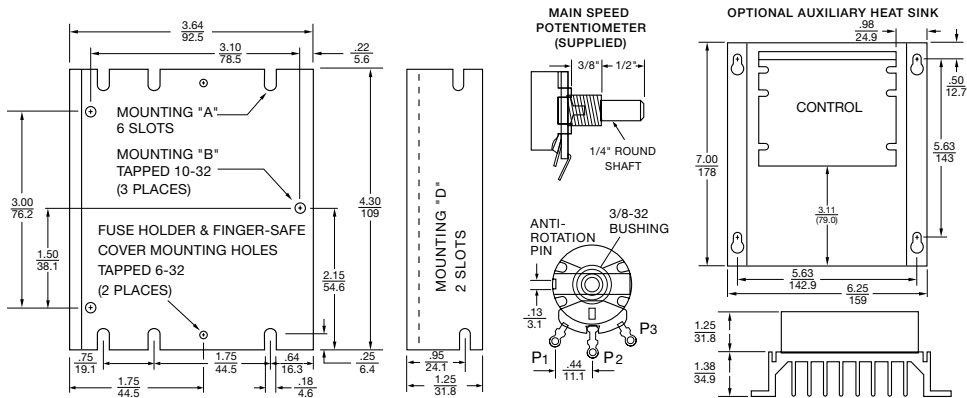

FIGURE 2 – MECHANICAL SPECIFICATIONS (Inches/mm)



4 APPLICATION INFORMATION

- 4.1 Motor Type** – The control is designed for permanent magnet (PM) and Shunt Wound DC motors. Controls operated on 115 Volt AC line input are designed for 90 Volt SCR rated motors. Controls operated on 230 Volt AC line input are designed for 180 and 90 Volt SCR rated motors. Use of motors with higher rated voltage will result in a reduction of the available maximum speed. Also, if the motor is not an SCR rated type, the actual AC line current at full load and full speed should not exceed the motor's DC nameplate current rating.
- 4.2 Torque Requirements** – The motor selected for the application must be capable of supplying the necessary torque. In order to ensure the motor is not overloaded, a DC ammeter should be connected in series with the armature. Be sure the current under full load does not exceed the motor nameplate rating.

4.3 Acceleration Start – The control contains an adjustable acceleration start feature which allows the motor to smoothly accelerate from zero speed to full speed over a time period of 0.2 - 10 seconds. The acceleration trippot (ACCEL) is factory set for 2 seconds.

4.4 Limitation In Use – The control is designed for use on machine applications.



CAUTION! Consult our Sales Department before using this control on constant horsepower applications such as saws and drill presses. Do not use this control in an explosive atmosphere. Be sure the control is used within its ratings. Follow all instructions carefully.

4.5 Armature Switching – Do not wire the control for armature switching without taking proper precautions. See Section 13.2, on page 29.



WARNING! Do not switch the armature in and out of circuit or catastrophic failure will result. If armature switching is required for reversing or dynamic braking, use Model KBMG, KBRG, KBPB, KBCC-R.

4.6 Step-Down Transformer and AC Line Switching – When using a step-down transformer (460 Volts AC to 230 Volts AC), be sure the output current rating of the transformer is at least 3 times the current rating of the motor. Do not switch the primary side of the transformer to disconnect power or catastrophic failure can result. Always disconnect the control from the secondary side of the transformer.

5 MOUNTING INSTRUCTIONS

It is recommended that the control be mounted on a flat surface with adequate ventilation. Leave enough room to allow for AC line, motor connections, and other wiring that is required. Care should be taken to avoid extreme hazardous locations where physical damage can occur. When mounting the control in an enclosure, the enclosure should be large enough to allow for proper heat dissipation so that the ambient temperature does not exceed 45 °C (113 °F) at full rating. See Figure 2, on page 11.

6 WIRING INSTRUCTIONS



WARNING! Read Safety Warning, on page 6, before using this control. Disconnect the main power when making connections to the control. To avoid electric shock be sure to properly ground control.

Important Application Note: To avoid erratic operation, do not bundle the AC line and motor wires with wires from signal following, start/stop contacts, or any other signal wires. Also, do not bundle motor wires from multiple controls in the same conduit. Use shielded cables on all signal wiring over 12" (30 cm). The shield should be earth grounded on the control side only. Wire the control in accordance with the National Electrical Code requirements and other local codes that may apply.

TABLE 3 – MINIMUM SUPPLY WIRE SIZE REQUIREMENTS

Maximum Motor Current (Amps DC)	90 - 130 Volt DC Motors (Maximum HP)	180 Volt DC Motors (Maximum HP)	Minimum Wire Size (Cu)			
			Maximum 50 Ft.		Maximum 100 Ft.	
			AWG	mm ²	AWG	mm ²
6	.5	1	16	1.3	14	2.1
12	1	2	14	2.1	12	3.3
16	1.5	3	12	3.3	12	3.3

- 6.1 AC Line Connection** – Wire the AC line to Terminals “L1” (Line Fuse) and “L2”, as shown in Figure 1, on page 10. If one of the AC line inputs is a neutral (N), wire it to Terminal “L2”.



CAUTION! The rated AC line voltage (115, 208/230) of the control must match the actual AC line input voltage. See Section 7.1, on page 19.

Model KBMM-125 operates on 115 Volt AC line input only. Model KBMM-225 operates on 208/230 Volt AC line input only. Model KBMM-225D operates on 115 Volt AC line input when Jumper J1 is set to the “115” position and operates on 208/230 Volt AC line input when Jumper J1 is set to the “230” position.

AC Line On/Off Switch – To remove power to the control, a separate AC line switch should be used. Use a single pole switch for hot and neutral AC supply lines and a double pole switch for 2-hot AC supply lines. This switch can also be used as a “Safety Disconnect”.

- 6.2 Ground Connection** – Connect the ground wire (earth) to the control chassis.

6.3 Permanent Magnet (PM) Motor Connection – Wire the motor armature positive lead (+) to Terminal “A+” (Armature Fuse) and the negative lead (-) to Terminal “A-”, as shown in Figure 1, on page 10. On Models KBMM-225 and KBMM-225D, be sure Jumper J2 is set to the corresponding motor voltage, as described in Section 7.2, on page 20. Be sure the correct Plug-In Horsepower Resistor® is installed, as described in Section 9, on page 21.

6.4 Motor Field Connection (Shunt Wound Motors Only)

6.4.1 Full Voltage Field – Wire the field positive (+) lead to Terminal “F+” and the negative lead (-) to Terminal “F-”, as shown in Figure 1, on page 10, and as described in Table 4.

6.4.2 Half Voltage Field – For 90 Volt DC motors with 50 Volt DC fields and 180 Volt DC motors with 100 Volt DC fields, wire the field positive lead (+) to Terminal “F+” and the negative lead (-) to Terminal “L1” (Line Fuse), as described in Table 4.

Notes: **1.** Do not connect motor armature leads to Terminals “F+” and “F-”. **2.** Do not use Terminals “F+” and “F-” for any purpose other than to power the field of a shunt wound motor. **3.** Shunt wound motors may be damaged if the field remains energized without armature rotation for an extended period of time.

TABLE 4 – FIELD CONNECTION (Shunt Wound Motors Only)

Model	AC Line Input Voltage (Volts AC)	Armature Voltage (Volts DC)	Field Voltage (Volts DC)	Terminal Connections
KBMM-125	115	0 - 90	100	F+, F-
			50	F+, L1
KBMM-225	208 / 230	0 - 180	200	F+, F-
		0 - 90*	100	F+, L1
KBMM-225D	115	0 - 90	100	F+, F-
			50	F+, L1
	208 / 230	0 - 180	200	F+, F-
	208 / 230	0 - 90*	100	F+, L1

* Step-down operation.

6.5 Remote Main Speed Potentiometer Connection – The control is supplied with a Main Speed Potentiometer to control motor speed. Wire the low side of the potentiometer to Terminal “P1”. Wire the wiper of the potentiometer to Terminal “P2”. Wire the high side of the potentiometer to Terminal “P3”. See Figure 3.

6.6 Voltage Following Connection – An *isolated* 0 - 9 Volt DC analog signal input can be used to control motor speed in lieu of the Main Speed Potentiometer. The control output voltage will linearly follow the analog signal input. **The signal input must be isolated from the AC line.** Connect the signal input positive lead (+) to Terminal “P2” and the negative lead (-) to Terminal “P1”, as shown in Figure 4. The source impedance of the signal input should be 10 k Ω or less. The MAX Trimpot is not operational in voltage following mode. Use the MIN trimpot to set an initial value of input signal. If necessary, use auxiliary trimpots to scale and/or limit the input voltage.

CAUTION! Do not earth ground any input terminals.

Notes: **1.** If an isolated signal input is not available, or if using a 4 - 20 mA DC signal input, install the optional plug-on SI-6 Signal Isolator (Part No. 9444). This will also allow direct connections to process controllers and microprocessors. **2.** If multiple follower motors are to be controlled from a single lead motor or a single Main Speed Potentiometer, install the optional KBSI-240D Signal Isolator (Part No. 9431). **3.** Terminal “F-” may be used in lieu of Terminal “P1”.

FIGURE 3 – REMOTE MAIN SPEED POTENTIOMETER CONNECTION

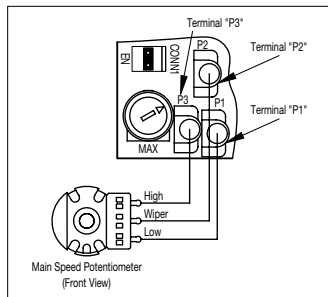
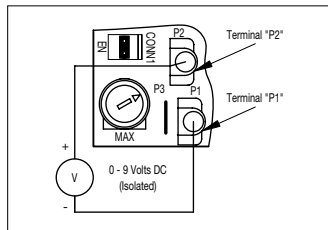

FIGURE 4 – VOLTAGE FOLLOWING CONNECTION



- 6.7 Enable Circuit Connection** – The control can be started and stopped with an Enable Circuit (close to run, open to stop), as described below.



WARNING! The Enable Circuit is never to be used as a Safety Disconnect since it is not fail-safe. Use only the AC line for this purpose.

- 6.7.1 Enable Switch or Contact Wired to the Enable Connector** – Using the wired mating connector that is supplied with the control, wire the switch or contact to the Enable connector (CONN1), as shown in Figure 5. When the switch or contact is closed, the motor will accelerate to the Main Speed Potentiometer setting. When the switch or contact is opened, the motor will decelerate to stop. An open collector (PNP) can be wired in lieu of a switch or contact.

Notes: 1. To use the Enable Circuit, remove the jumper that is factory installed on CONN1. 2. The deceleration time can only be made longer than the normal coasting time of the load.

FIGURE 5 – ENABLE SWITCH OR CONTACT WIRED TO THE ENABLE CONNECTOR

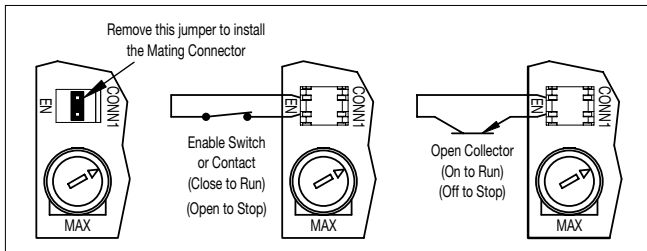

- 6.7.2 Enable Switch or Contact Wired to the Main Speed Potentiometer** – Wire the switch or contact in series with the Main Speed Potentiometer high side and Terminal “P3” on the control, as shown in Figure 6, on page 17. Be sure the jumper is installed on the Enable Connector (CONN1). When the switch or contact is closed, the motor will accelerate to the Main Speed Potentiometer setting. When the switch or contact is opened, the motor will decelerate to the MIN Trimpot setting (factory set to 0

Volts DC). If the MIN Trimpot is set to other than 0 Volts DC, the motor will run at that speed when the switch or contact is opened. An open collector (PNP) can be wired in lieu of a switch or contact.

Note: *The deceleration time can only be made longer than the normal coasting time of the load.*

FIGURE 6 – ENABLE SWITCH OR CONTACT WIRED TO THE MAIN SPEED POTENTIOMETER

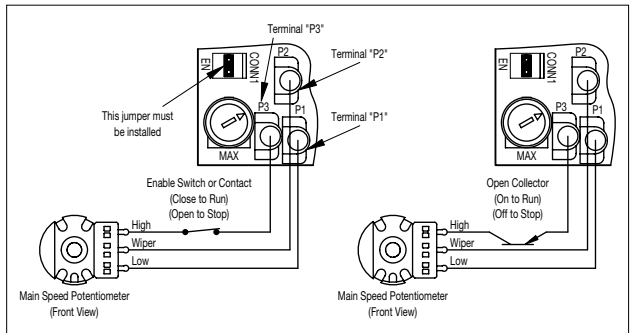

6.8 Inhibit Circuit Connection – The control can be stopped and started with an Inhibit circuit (close to stop, open to run). Wire the switch or contact to Terminals “I1” and “I2”, as shown in Figure 7. When the switch or contact is closed, the motor will coast to stop. When the switch or contact is opened, the motor will accelerate to the Main Speed Potentiometer setting. An open collector (NPN) can be wired in lieu of a switch or contact.



WARNING! The Inhibit Circuit is never to be used as a Safety Disconnect since it is not fail-safe. Use only the AC line for this purpose.

FIGURE 7 – INHIBIT SWITCH OR CONTACT WIRED TO THE INHIBIT TERMINALS

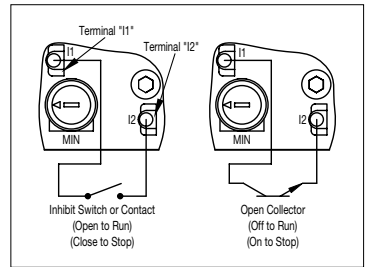

6.9 DC Tach-Generator Connection – A DC tach-generator can be used for load regulation of 1% of the set speed. Note: Jumper J2 must be set to the “T” position for tach-generator operation. Connect the tach-generator as follows.

Application Notes – 1. The tach-generator input circuit is designed for a 7 Volt or 50 Volt per 1000 RPM DC tach-generator used with an 1800 RPM motor. **2.** Initially set the IR Comp Trimpot fully counterclockwise. Once the tach-generator is connected, the IR Comp Trimpot may be increased for additional speed stabilization.

6.9.1 Seven (7) Volt per 1000 RPM Tach-Generator –

Connect the tach-generator positive lead (+) to Terminal “T” and the negative lead (-) to Terminal “I2”, as shown in Figure 8.

6.9.2 Fifty (50) Volt per 1000 RPM Tach-Generator –

Connect the tach-generator positive lead (+) to Terminal “B” and the negative lead (-) to Terminal “I2”, as shown in Figure 9.

6.9.3 Other Tach-Generator Voltages – The tach-generator input circuit is designed for a 7 Volt or 50 Volt per 1000 RPM DC tach-generator used with an 1800 RPM motor. For a tach-generator other than 7 Volts or 50 Volts per 1000 RPM, or for a motor other than 1800 RPM, an external 1/2 Watt resistor (RT) must be installed. Install RT in series with the

FIGURE 8 – DC TACH-GENERATOR CONNECTION (7 VOLTS PER 1000 RPM)

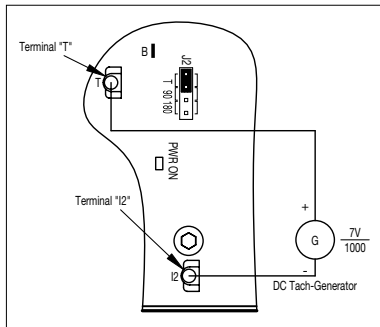
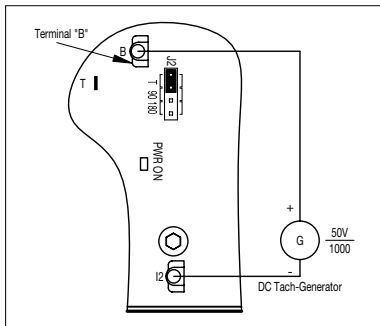

FIGURE 9 – DC TACH-GENERATOR CONNECTION (50 VOLTS PER 1000 RPM)



tach-generator. Connect one end of RT to Terminal “T”, connect the other end of RT to the tach-generator positive lead (+), and connect the negative lead (-) of the tach-generator to Terminal “I2”. See Figure 10.

The value of RT (Ω) can be calculated using the following formula: $RT = (1.3 \times VT \times S) - 16000 \Omega$
Where “VT” is the tach-generator voltage (in Volts per 1000 RPM) and “S” is the base speed of the motor (in RPM).

Example: If a 20 Volt per 1000 RPM tach-generator is to be used with a 3600 RPM motor:

$$RT = (1.3 \times 20 \times 3600) - 16000 = 77600 \Omega$$

Choose the closest 1/2 Watt resistor value, which is 75000 Ω (75 k Ω).

FIGURE 10 – OTHER DC TACH-GENERATOR CONNECTION

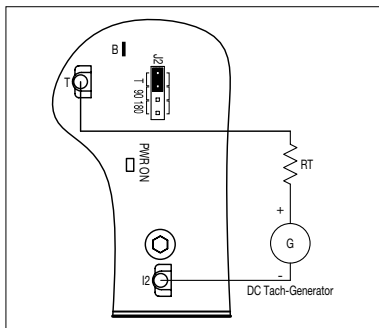

7 SETTING SELECTABLE JUMPERS

The control has selectable jumpers which must be set before it can be used. See Figure 1, on page 10, for the location of jumpers.

7.1 AC Line Input Voltage Selection (Jumper J1 (Model KBMM-225D Only)) – Jumper J1 is factory set to the “230” position for 208/230 Volt AC line input. For 115 Volt AC line input, set Jumper J1 to the “115” position. See Figure 11, on page 20.

Notes: **1.** Jumper J1 is installed on Model KBMM-225D only. **2.** When Jumper J1 is set to the “115” position, Jumper J2 must be set to the “90” position (or the “T” position if using a tach-generator).

7.2 Motor Voltage and DC Tach-Generator Selection –

Jumper J2 is factory set to the “90” position on Model KBMM-125, for 90 Volt DC motors, and set to the “180” position, on Models KBMM-225, 225D, for 180 Volt DC motors. To set Models KBMM-225, 225D for step-down operation (208/230 Volt AC line input and 90 Volt DC output), set Jumper J2 to the “90” position). To set the control for tach-generator connection, set Jumper J2 to the “T” position (all models). See Figure 12.

Notes: 1. On Model KBMM-125, the “180” position is not available on Jumper J2. 2. On Model KBMM-225D, do not set the output voltage to 180 Volts DC when the AC line input is set to 115 Volts.

FIGURE 11 – AC LINE INPUT VOLTAGE SELECTION (JUMPER J1) – MODEL KBMM-225D ONLY







J1 Set for 208/230 Volt AC Line Input (Factory Setting)	J1 Set for 115 Volt AC Line Input
	

FIGURE 12 – MOTOR VOLTAGE & DC TACH-GENERATOR SELECTION (JUMPER J2)

Model KBMM-125		Models KBMM-225 and KBMM-225D		
J2 Set for 90 Volt Motor (Factory Setting)	J2 Set for Tach-Generator	J2 Set for 180 Volt Motor (Factory Setting)	J2 Set for 90 Volt Motor *	J2 Set for Tach-Generator
				

* Be sure jumper for 90 Volt DC output is installed in the two center pins, as shown.

8 AC LINE AND ARMATURE FUSING

All fuses should be normal blow ceramic 3AG, MDA, or equivalent. On domestic 230 Volt AC lines, separate branch circuit protection for each line must be used. The optional Barrier Terminal Board (Part No. 9897) contains prewired AC line and armature fuse holders, as described in Section 14.3, on page 30.

An AC Line Fuse (supplied separately) must be installed in the AC line Fuse Holder and an Armature Fuse (supplied separately) must be installed in the Armature Fuse Holder, as shown in Figure 1, on page 10. Select the correct fuses, as shown in Table 5.

8.1 AC Line Fuse – The AC Line Fuse protects the control against catastrophic failure. If the AC Line Fuse blows, the control is miswired, the motor is shorted or grounded, or the control is defective.

Note: Fuse each AC line conductor that is not at ground potential.

8.2 Armature Fuse – The Armature Fuse provides overload protection for the motor and control. The Armature Fuse required can be calculated by multiplying the maximum DC Motor Current times 1.7.

TABLE 5 – AC LINE & ARMATURE FUSE SELECTION

90 - 130 Volt DC Motors (HP)	180 Volt DC Motors (HP)	Recommended Fuse Rating (Amps)	
		AC Line	Armature
1/100 – 1/50	1/50 – 1/25	12	1/3
1/50 – 1/30	1/25 – 1/15	12	1/2
1/30 – 1/20	1/15 – 1/10	12	3/4
1/20 – 1/12	1/10 – 1/6	12	1¼
1/12 – 1/8	1/6 – 1/4	12	2
1/8 – 1/5	1/4 – 1/3	12	2½
1/4	1/2	12	4
1/3	3/4	12	5
1/2	1	12	8
3/4	1½	12	12
1*	2*	15	15
1½*	3*	25	25

9 PLUG-IN HORSEPOWER RESISTOR®

Plug-In Horsepower Resistor® – A Plug-In Horsepower Resistor® (supplied separately) must be installed to match the control to the motor horsepower and voltage. Plug-In Horsepower Resistors® are available from your distributor. Install the Plug-In Horsepower Resistor®, as shown in Figure 1, on page 10. Select the correct Plug-In Horsepower Resistor® as shown in Table 6, on page 22.

Application Notes: **1.** The Plug-In Horsepower Resistor® is used to calibrate the IR Compensation and Current Limit based on motor horsepower and voltage. The Plug-In Horsepower Resistor® eliminates the need to recalibrate IR Compensation and Current Limit in most applications. **2.** Be sure the Plug-In Horsepower Resistor® is inserted completely into the mating sockets.

TABLE 6 – PLUG-IN HORSEPOWER RESISTOR® SELECTION

90 - 130 Volt DC Motors (HP)	180 Volt DC Motors (HP)	Plug-In Horsepower Resistor®	
		Value (Ohms)	Part No.
1/100 – 1/50	1/50 – 1/25	1	9833
1/50 – 1/30	1/25 – 1/15	.51	9834
1/30 – 1/20	1/15 – 1/10	.35	9835
1/20 – 1/12	1/10 – 1/6	.25	9836
1/12 – 1/8	1/6 – 1/4	.18	9837
1/8 – 1/5	1/4 – 1/3	.1	9838
1/4	1/2	.05	9839
1/3	3/4	.035	9840
1/2	1	.025	9841
3/4	1½	.015	9842
1*	2*	.01	9843
1½*	3*	.006	9850

* Indicates an Auxiliary Heat Sink (Part No. 9861, or equivalent) must be used to achieve rating indicated.

10 RECOMMENDED HIGH VOLTAGE DIELECTRIC WITHSTAND TESTING (Hi-Pot Testing)

Testing agencies such as UL, CSA, etc., usually require that equipment undergo a hi-pot test. In order to prevent catastrophic damage to the control, which has been installed in the equipment, it is recommended that the following procedure be followed. A typical hi-pot test setup is shown in Figure 13 on page 23. **Note: All controls have been factory hi-pot tested in accordance with UL requirements.**



WARNING! When performing the hi-pot test, disconnect the AC power.

FIGURE 13 – HI-POT TEST SETUP

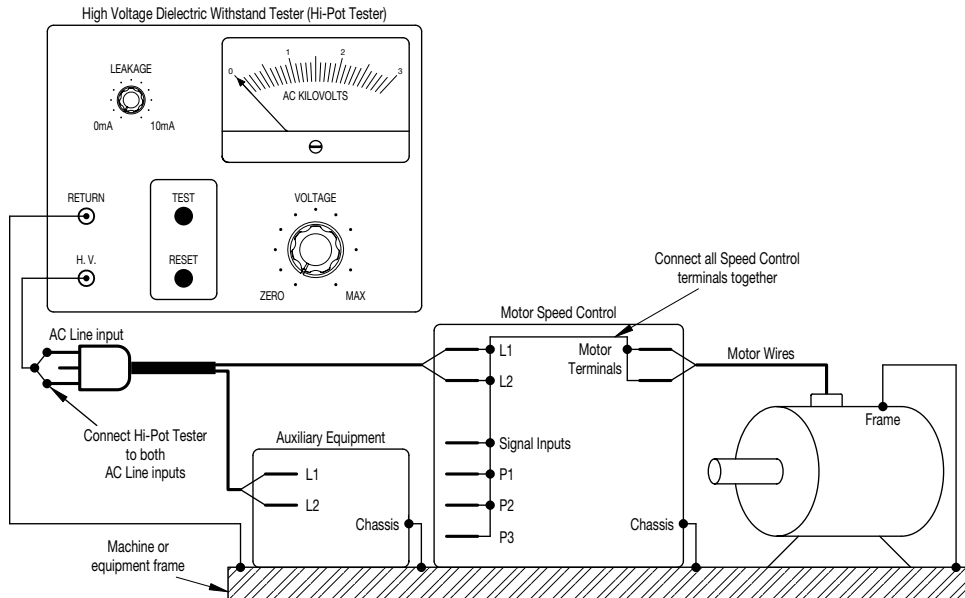

- 10.1** Connect all equipment AC power input lines together and connect them to the H.V. lead of the Hi-Pot Tester. Connect the RETURN of the Hi-pot Tester to the frame on which the control and other auxiliary equipment are mounted.

10.2 The Hi-Pot Tester must have an automatic ramp-up to the test voltage and an automatic ramp-down to zero voltage.

Note: *If the Hi-Pot Tester does not have automatic ramping, then the hi-pot output must be manually increased to the test voltage and then manually reduced to zero. This procedure must be followed for each machine to be tested. A suggested Hi-Pot Tester is Slaughter Model 2550.*

CAUTION! Instantaneously applying the hi-pot voltage will cause irreversible damage to the control.

11 TRIMPOT ADJUSTMENTS

The control contains trimpots which have been factory set for most applications. Some applications may require readjustment of the trimpots in order to tailor the control for a specific requirement. Readjust the trimpots as described below. See Figure 1, on page 10, for the location of trimpots.



Warning! If possible, do not adjust trimpots with the main power applied. If adjustments are made with the main power applied, an insulated adjustment tool must be used and safety glasses must be worn. High voltage exists in this control. Electrocution can result if caution is not exercised. Safety Warning, on page 6, must be read and understood before proceeding.

Note: *In order for the IR Compensation and Current Limit settings to be correct, the proper Plug-In Horsepower Resistor® must be installed for the particular motor and input voltage being used. See Section 9, on page 21.*

11.1 Acceleration Trimpot (ACCEL) – The ACCEL Trimpot is provided to allow for a smooth start over an adjustable time period each time the AC power is applied or the Main Speed Potentiometer is adjusted to a higher speed. The ACCEL Trimpot has been factory set to 2 seconds, which is the amount of time it will take for the motor to accelerate from zero speed to full speed. To increase the acceleration time, rotate the ACCEL Trimpot clockwise. To decrease the acceleration time, rotate the ACCEL Trimpot counterclockwise. See Figure 14.

**FIGURE 14
ACCEL TRIMPOT RANGE**

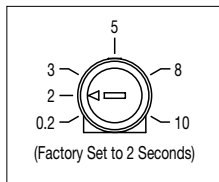

11.2 Deceleration Trimpot (DECEL) – The DECEL Trimpot controls the amount of ramp-down time when the Main Speed Potentiometer is adjusted to a lower speed. The DECEL Trimpot has been factory set to 2 seconds, which is the amount of time it will take for the motor to decelerate from full speed to zero speed. To increase the deceleration time, rotate the DECEL Trimpot clockwise. To decrease the deceleration time, rotate the DECEL Trimpot counterclockwise. See Figure 15.

Note: *The deceleration time cannot be made less than the natural coast time of the motor and actual load.*

11.3 Minimum Speed Trimpot (MIN) – The MIN Trimpot sets the minimum speed of the motor when the Main Speed Potentiometer is set fully counterclockwise. The MIN Trimpot is factory set to 0 % of base motor speed. To increase the minimum speed, rotate the MIN Trimpot clockwise. To decrease the minimum speed, rotate the MIN Trimpot counterclockwise. See Figure 16.

Note: *Readjusting the MIN Trimpot will affect the maximum speed setting. Therefore, it is necessary to readjust the MAX Trimpot if readjusting the MIN Trimpot. It may be necessary to repeat these adjustments until both the minimum and maximum speeds are set to the desired levels.*

11.4 Maximum Speed Trimpot (MAX) – The MAX Trimpot sets the maximum speed of the motor when the Main Speed Potentiometer is set fully clockwise. The MAX Trimpot is factory set to 100 % of base motor speed. To increase the maximum speed, rotate the MAX Trimpot clockwise. To decrease the maximum speed, rotate the MAX Trimpot counterclockwise. See Figure 17.

CAUTION! Do not set the maximum speed above the rated motor RPM since unstable motor operation may occur.

**FIGURE 15
DECEL TRIMPOT RANGE**

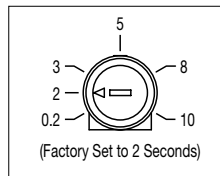

**FIGURE 16
MIN TRIMPOT RANGE**

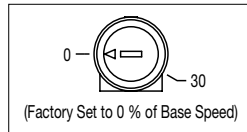

**FIGURE 17
MAX TRIMPOT RANGE**

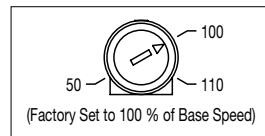



Warning! If possible, do not adjust trimpots with the main power applied. If adjustments are made with the main power applied, an insulated adjustment tool must be used and safety glasses must be worn. High voltage exists in this control. Electrocution can result if caution is not exercised. Safety Warning, on page 6, must be read and understood before proceeding.

11.5 Current Limit Trimpot (CL) – The CL Trimpot sets the current limit (overload), which limits the maximum current (torque) to the motor. The CL also limits the AC line inrush current to a safe level during startup. The CL Trimpot is factory set to 1.5 times the full load rating of the motor. To increase the current limit, rotate the CL Trimpot clockwise (**do not exceed 2 times motor current rating (maximum clockwise position)**). To decrease the current limit, rotate the CL Trimpot counterclockwise. See Figure 18.

FIGURE 18
CL TRIMPOT RANGE

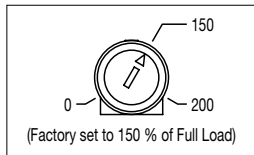

Note: The correct value Plug-In Horsepower Resistor® must be installed for the CL to operate properly. Calibration of the CL Trimpot is normally not required when the proper Plug-In Horsepower Resistor® is installed.

To Recalibrate the CL Trimpot:

- 1 Disconnect the AC power and wire a DC ammeter in series with either motor armature lead.

Note: If only an AC ammeter is available, wire it in series with either AC line input lead.

- 2 Set the Main Speed Potentiometer to approximately 30 - 50 % clockwise position.
- 3 Set the CL Trimpot fully counterclockwise. The CL LED will illuminate red.
- 4 Lock the motor shaft (be sure the CL Trimpot is set fully counterclockwise).
- 5 Apply power and rotate the CL Trimpot clockwise until the desired current reading is observed on the DC ammeter. Factory Current Limit setting is 1.5 times the full load rating of the motor (with a DC ammeter

wired in series with the motor armature). If using an AC ammeter wired in the AC line input, the factory Current Limit setting will read 0.75 times the full load rating of the motor.

Do not exceed 2 times motor current rating (maximum clockwise position).

Note: On cyclical loads, it may be normal for the CL LED to momentarily flash.



WARNING! Do not leave motor shaft locked for more than 2-3 seconds or motor damage may result.

11.6 IR Compensation Trimpot (IR) – The IR Trimpot sets the amount of compensating voltage required to keep the motor speed constant under changing loads. If the load does not vary substantially, the IR Trimpot may be set to a minimum level (approximately 1/4 of full clockwise rotation). The IR Trimpot is factory set to provide 3 Volts of compensation for controls with 90 Volt DC output and 6 Volts of compensation for controls with 180 Volt DC output. To increase the amount of compensating voltage, rotate the IR Trimpot clockwise. To decrease the amount of compensating voltage, rotate the IR Trimpot counterclockwise. See Figure 19.

FIGURE 19 – IR TRIMPOT RANGE

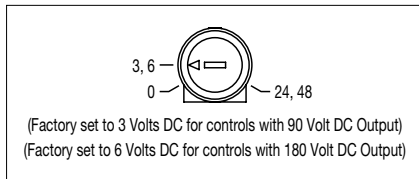

Notes: **1.** The correct value Plug-In Horsepower Resistor® must be installed for the IR Compensation to operate properly. Calibration of the IR Trimpot is normally not required when the proper Plug-In Horsepower Resistor® is installed. **2.** Excessive IR Compensation will cause the motor to become unstable, which causes cogging. **3.** For tach-generator feedback applications, set the IR Trimpot fully counterclockwise. See Section 6.9, on page 18.

To Recalibrate the IR Trimpot:

- 1 Set the IR Trimpot to approximately 25 % rotation.



Warning! If possible, do not adjust trimpots with the main power applied. If adjustments are made with the main power applied, an insulated adjustment tool must be used and safety glasses must be worn. High voltage exists in this control. Electrocution can result if caution is not exercised. Safety Warning, on page 6, must be read and understood before proceeding.

- 2 Run the motor unloaded at approximately 1/3 speed and record the RPMs.
- 3 Run the motor with the maximum load and adjust the IR Trimpot so that the motor speed under load equals the unloaded speed recorded in step 2.
- 4 Remove the load and recheck the RPMs.
- 5 If the unloaded RPM has changed, repeat steps 2 - 4 for more exact regulation. The control is now compensated to provide minimal speed change due to changing loads.

12 DIAGNOSTIC LEDs

The control is designed with PC board mounted LEDs to display the control's operational status. See Figure 1, on page 10, for the location of the LEDs.

12.1 Power On (PWR ON) – The PWR ON LED will illuminate green when the AC line is applied to the control.

12.2 Current Limit (CL) – The CL LED will illuminate red when the control goes into current limit, indicating that the current limit set point has been reached (set by the CL Trimpot). See Section 11.5, on page 26.

13 SWITCHING CIRCUITS

13.1 AC Line Switching – The control can be turned “on” and “off” using the AC line (no waiting time is required). Auto-Inhibit[®] circuitry automatically resets critical components each time the AC line is interrupted. This, along with Acceleration Start and CL, provides a smooth start each time the AC line is applied.



WARNING! Do not disconnect and reconnect the motor armature with the AC line applied or catastrophic failure will result. See Section 13.2.

13.2 Armature Switching and Dynamic

Braking – If the armature is to be disconnected and reconnected with the AC power applied, wire a relay (or contactor) and a brake resistor (RB) in the armature circuit. The Inhibit Circuit must be simultaneously activated when braking. Wire a double pole double throw (DPDT) mechanically ganged switch to the Inhibit Terminals and the relay (or contactor) coil, as shown in Figure 20. The resistance and wattage of RB must be chosen according to braking requirements.

When the switch is in the “Brake” position, the relay is deenergized and allows the motor voltage, via the N.C. contact, to be dissipated through RB and dynamically brake the motor. Simultaneously, the Inhibit is activated and the control output is electronically “extinguished”, which eliminates arcing.

When the switch is in the “Run” position, the N.C. contact opens, the N. O. contact closes, the Inhibit is deactivated, and the motor begins to accelerate (according to the setting of the ACCEL Trimpot) to the Main Speed Potentiometer setting.



WARNING! The Inhibit Circuit (Terminals “I1” and “I2”) is never to be used as a Safety Disconnect since it is not fail-safe. Use only the AC line for this purpose.

FIGURE 20 – TYPICAL DYNAMIC BRAKE CIRCUIT CONNECTION

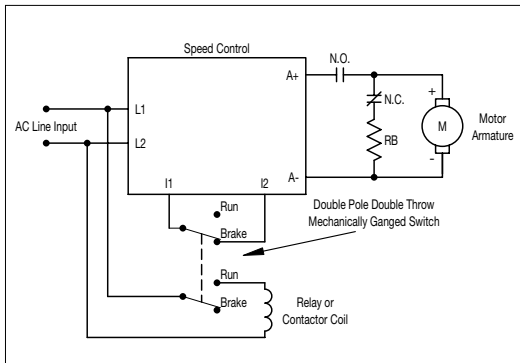

13.3 Reversing and Dynamic Braking – The optional patented APRM® provides anti-plug “instant” reversing and solid state dynamic braking. The APRM® is built-in as standard on Models KBCC-R™ and KBPB™. Contact the Sales Department for more information.

14 OPTIONAL ACCESSORIES

14.1 Auxiliary Heat Sink (Part No. 9861) – Doubles the horsepower rating of the control.

14.2 Barrier Terminal Accessory Kit (Part No. 9883) – When used with the Auxiliary Heat Sink, it converts the quick-connect terminals of the control to a barrier terminal block.

14.3 Barrier Terminal Board (Part No. 9897) – Converts the quick-connect terminals of the control to a barrier terminal block. Contains PC board mounted line and armature fuse holders (fuses supplied separately). Plugs onto the quick-connect terminals of the control.

14.4 SI-6 Signal Isolator (Part No. 9444) – Provides isolation between non-isolated signal sources and the control. Plugs onto the quick-connect terminals of the control.

14.5 Run/Brake Module (Part No. 9952) – Used for applications that require rapid stopping of the motor. Contains a barrier terminal block.

14.6 Dial Plate and Knob Kit (Part No. 9832) – Provides indication of the Main Speed Potentiometer position (0 - 100 %).

14.7 Finger-Safe Cover (Part No. 9564) – Converts the control from open chassis to the IP-20 standard. (Fuse holders must be removed when installing the finger-safe cover.)

14.8 DIN Rail Mounting Kit (Part No. 9995)

14.9 KBAP-240D Current Sensing Overload Protector (Part No. 9106) – Provides overload current sensing and protection of DC motors and speed controls rated 1/8 - 3 HP by sensing armature current. Operates on 115 or 230 Volt AC line input.

- 14.10 KBEP-240D Electronic Potentiometer (Part No. 9108)** – Provides digital type control of motor speed. Replaces a standard rotary potentiometer with a set of customer supplied momentary push buttons or membrane switches. Operates on 115 or 230 Volt AC line input.
- 14.11 KBET-240D Electronic Tachometer (Part No. 9469)** – Provides an isolated tack-feedback signal and an isolated voltage follower signal from an open collector (Hall, magnetic, inductive, optical) or 2-wire inductive pickup (encoder). Operates on 115 or 230 Volt AC line input
- 14.12 RFI Filters** – Provide RFI and EMI suppression. Complies with CE Council Directive 89/336/EEC relating to the Class A Industrial Standard and Class B Residential Standard. Filters are available in remote or undermount types. See Table 7.

TABLE 7 – RFI FILTER SELECTION

Model	Part No.	Current Rating (RMS Amps)	Mounting	Class
KBRF-200A	9945C	24	Remote	A - Industrial
KBRF-250	9509	10	Undermount	A - Industrial
KBRF-300	9484	16	Remote	B - Residential *
KBRF-350	9511	10	Undermount	B - Residential *

* Also meets Industrial Standard.

LIMITED WARRANTY

For a period of 5 years from the date of original purchase, KB Electronics, Inc. will repair or replace, without charge, devices which our examination proves to be defective in material or workmanship. This warranty is valid if the unit has not been tampered with by unauthorized persons, misused, abused, or improperly installed and has been used in accordance with the instructions and/or ratings supplied. The foregoing is in lieu of any other warranty or guarantee, expressed or implied. KB Electronics, Inc. is not responsible for any expense, including installation and removal, inconvenience, or consequential damage, including injury to any person, caused by items of our manufacture or sale. Some states do not allow certain exclusions or limitations found in this warranty and therefore they may not apply to you. In any event, the total liability of KB Electronics, Inc., under any circumstance, shall not exceed the full purchase price of this product. (rev 2/2000)

COPYRIGHT © 2004 by KB ELECTRONICS, INC.

All rights reserved. In accordance with the United States Copyright Act of 1976, no part of this publication may be reproduced in any form or by any means without permission in writing from KB Electronics, Inc. (8/22/02)



KB Electronics, Inc.

12095 NW 39th Street, Coral Springs, FL 33065-2516 • (954) 346-4900 • Fax (954) 346-3377
Outside Florida Call TOLL FREE (800) 221-6570 • E-mail – info@kbelectronics.com
www.kbelectronics.com